



Yacht Boy 230 Yacht Boy 230 Italia



D

Bei Eingriffen Schutzmaßnahmen für MOS-Bauteile beachten!

Das Gerät muß auch nach der Reparatur den Sicherheitsbestimmungen nach DIN/IEC 65 VDE 0860 entsprechen.

Inhaltsverzeichnis	Seite
Ausbauhinweise	2-3
Ersatzteilliste	4-5
Sicherheitsvorschriften	6-9
Behandlung von Chip - Bauteilen	9-10
Abgleich	11-14
Druckplatten	15-20
Schaltbild	21-22
Blockschaltbild	23-24

GB

N.B. When carrying out repairs, observe MOS precautions!

After the unit has been repaired, it should still meet the DIN/IEC 65 VDE 0860 safety requirements.

Contents	Page
Disassembly Instructions	2-3
Spare Parts List	4-5
Safety requirements	6-9
Handling of Chip Components	9-10
Alignment	11-14
Printed Circuit Boards	15-20
Connection Diagram	21-22
Block Diagram	23-24

Technische Daten

Spannungsversorgung:

Durch Batterien: 3x1,5V-Mignonzellen (IEC LR6/UM-3/AA)
1x 3V-Lithiumbatterie (CR 2016)

Externe Versorgung: 4,5 V, Steckernetzteil NR 30-75

Frequenzbänder:

	YB 230		YB 230 Italia
FM:	87,5	- 108 MHz	87,5 - 108 MHz
LW:	140	- 290 MHz	140 - 290 MHz
MW:	515	- 1630 MHz	515 - 1630 MHz
SW1:	2300	- 2500 kHz	3900 - 4300 kHz
SW2:	3200	- 3400 kHz	4300 - 4750 kHz
SW3:	3900	- 4000 kHz	4750 - 5060 kHz
SW4:	4750	- 5060 kHz	5800 - 6200 kHz
SW5:	5800	- 6200 kHz	6200 - 6800 kHz
SW6:	7100	- 7500 kHz	7100 - 7500 kHz
SW7:	9500	- 9900 kHz	9500 - 9900 kHz
SW8:	11650	- 12050 kHz	11650 - 12050 kHz
SW9:	13600	- 13800 kHz	13600 - 13800 kHz
SW10:	15100	- 15600 kHz	15100 - 15600 kHz
SW11:	17550	- 17900 kHz	17550 - 17900 kHz
SW12:	21450	- 21850 kHz	21450 - 21850 kHz
SW13:	25600	- 26100 kHz	25600 - 26100 kHz

Ausgangsleistung:

600 mW Spitzenleistung mit dem eingebauten Lautsprecher.
2x80 mW Spitzenleistung bei Kopfhörer-Betrieb.

Zwischenfrequenzen:

10,7 MHz - FM
455 kHz - AM

Antennen:

Teleskopantenne für FM- und SW-Empfang,
eingebaute Ferritstab-Antenne für MW und LW.

Ausbauhinweise

Rückwand abnehmen

- 2 Schrauben (53,56) herausschrauben.
- Mit Schraubendreher bei den Rastnasen **a** die Rückwand (51) abhebeln.
- Antennenleitung abschrauben (Schraube 28).

Vorderteil abnehmen

- Schraube (63) herausschrauben.
- Senderwahlknopf (22) abziehen.
- 2 Rastnasen **b** austrasten.
- Lautsprecherleitung am Lautsprecher ablöten.

µC-Platte ausbauen

- Vorderteil abnehmen.
- 2 Schrauben (64) herausschrauben.
- µC-Platte abnehmen.
- Steckverbindung lösen.
- Beim Einbau darauf achten, daß der Ein/Aus-Schalter in den Schalterknopf (8) eingreift.

HF/NF-Platte ausbauen

- Die aufgeklebte Senderskala abnehmen.
- Senderwahlknopf zu einem Anschlag drehen.
- 2 Schrauben (28) herausschrauben und Zahnrad (62) abziehen (Stellung merken!). Zahnrad (61) vorsichtig abziehen, aber nicht vom Seilzug nehmen.
- 4 Rastnasen an der HF/NF-Platte austrasten.
- HF/NF-Platte vorsichtig abnehmen. Achtung! Anschlüsse der Ferritantenne nicht abreißen.
- Steckverbindung zur µC-Platte abziehen.

Specification

Power Supplies:

Battery operation: Three 1.5V HP 7 batteries (IEC LR6/UM-3/AA)
One 3V lithium battery (CR 2016)

External power supply: 4.5 V power supply unit NR 30-75

Wavebands:

	YB 230		YB 230 Italia
FM:	87,5	- 108 MHz	87,5 - 108 MHz
LW:	140	- 290 MHz	140 - 290 MHz
MW:	515	- 1630 MHz	515 - 1630 MHz
SW1:	2300	- 2500 kHz	3900 - 4300 kHz
SW2:	3200	- 3400 kHz	4300 - 4750 kHz
SW3:	3900	- 4000 kHz	4750 - 5060 kHz
SW4:	4750	- 5060 kHz	5800 - 6200 kHz
SW5:	5800	- 6200 kHz	6200 - 6800 kHz
SW6:	7100	- 7500 kHz	7100 - 7500 kHz
SW7:	9500	- 9900 kHz	9500 - 9900 kHz
SW8:	11650	- 12050 kHz	11650 - 12050 kHz
SW9:	13600	- 13800 kHz	13600 - 13800 kHz
SW10:	15100	- 15600 kHz	15100 - 15600 kHz
SW11:	17550	- 17900 kHz	17550 - 17900 kHz
SW12:	21450	- 21850 kHz	21450 - 21850 kHz
SW13:	25600	- 26100 kHz	25600 - 26100 kHz

Output:

600 mW peak output with the built-in loudspeaker.
2x80 mW peak on headphone operation.

Intermediate Frequencies:

10.7 MHz - FM
455 kHz - AM

Aerials:

Telescopic aerial for FM and SW reception.
Built-in ferrite rod aerial for MW and LW.

Disassembly Instructions

Removing the Rear Panel

- Unscrew two screws (53,56).
- Remove the rear panel when the latches **a** are disengaged using a screw driver.
- Unscrew the aerial lead (screw 28).

Removing the Front Panel

- Unscrew screw (63).
- Pull off the tuning knob (22).
- Disengage two latches **b**.
- Unsolder the loudspeaker lead from the loudspeaker.







Removing the µC Board





- Remove the front panel.
- Unscrew two screws (64).
- Remove the µC board.
- Disconnect the plug in connector.
- Note when reassembling that the on/off switch engages with the button (8).



Removing the RF/AF Board











- Remove the sticker on scale.
- Turn the tuning knob to either of its end stops.
- Unscrew two screws (28) and remove the tooth wheel (62) (note the position!). Remove the toothed wheel (61) carefully, but do not detach it from the cord drive.
- Disengage the four latches at the RF/AF board.
- Remove the RF/AF board carefully. Attention! Don't tear off the connections of the ferrite aerial.
- Disconnect the plug in connection to the µC board.

Ersatzteilliste / List of spare parts









POS. NR. POS. NO.	ABB. NR. FIG. NO.	SACHNUMMER PART NUMBER	ANZ. QUA.	BEZEICHNUNG 	DESCRIPTION 
1.		75986-435.51		GEHAEUSE-VORDERTEIL KPL.	CABINET FRONT ASSY
1.1		75986-435.91		GEHAEUSE-VORDERTEIL KPL.	CABINET FRONT ASSY
3.		75987-513.46		BATTERIEFACHDECKEL	BATTERY COMP. COVER
4.		75986-435.63		KLAPPE	FLAP
5.		75986-435.32		LAUTSPRECHER	SPEAKER
8.		75986-435.55		TASTE / EIN-AUS	KEY
9.		75986-435.61		RASTHEBEL	LOCKING LEVER
10.		75986-435.58		KNOPF/ LS U.BAND	KNOB
11.		75986-435.59		KNOPF / OPEN	KNOB
13.		75986-435.13		DISPLAY	DISPLAYPLATTE
16.		75986-435.33		DRUCKPLATTE	P.C. BOARD ASSY
17.		75986-435.68		SCALA	SCALA
17.1		75986-435.90		SCALA F. IT.	SCALA F. IT.
18.		75986-435.69		KONTAKT	CONTACT
19.		75987-509.65		KONTAKTMATTE "A"	RUBBER CONTACT STRIP
20.		75986-435.75		KONTAKFEDER	CONTACT SPRING
21.		75986-435.76		ABSCHIRMUNG	SCREENING, SHIELDING
22.		75987-513.47		DREHKNOPF	ROTARY KNOB
24.		75987-513.30		TRAGSCHLAUFE	CARRIER BAND
25.		75986-435.60		HEBEL	LEVER
26.		75986-435.83		FEDER	SPRING
29.		75987-509.69		ZUGFEDER	TENSION SPRING
30.		75986-435.80		ACHSE	SPINDLE; SHAFT
31.		75986-435.64		SEILROLLE	PULLEY
33.		75986-435.56		KNOPF-SCHLAF	KNOB
36.		75986-435.78		ACHSE	SPINDLE; SHAFT
37.		75987-513.29		ZWISCHENRAD	IDLER WHEEL
38.		75986-435.77		ACHSE	SPINDLE; SHAFT
39.		75986-435.65		SEILROLLE	PULLEY
41.		75986-435.82		KEGELFEDER/BATTERIE	CONCIAL SPIRAL SPRING/BATT.
42.		75986-435.27		FERRITANTENNE	FERRITE ANTENNA
43.		75986-435.54		TASTE / KLANG	KEY
44.		75986-435.73		BATTERIEKONTAKT "+"	BATTERY CONTACT
47.		75986-435.71		ANTENNENHALTER	AERIAL HOLDER
48.		75986-435.79		TELESKOPANTENNE	TELESCOPIC ANTENNA
49.		75986-435.74		KONTAKTFEDER	CONTACT SPRING
51.		75986-435.52		GEHAEUSE RUECKTEIL	HOUSING
52.		75986-435.72		HALTER	HOLDER
55.		75986-435.53		STUETZE	SUPPORT
58.		75986-435.70		KONTAKTGUMMI	CONTACT RUBBER
60.		75986-435.81		ZEIGER	POINTER
61.		75987-513.27		ANTRIEBSRAD	DRIVE WHEEL
62.		75987-513.28		ANTRIEBSRAD	DRIVE WHEEL
67.		75986-435.62		BATT.KONT./STUETZ-BATT.	BATT.CONT./SUPP.-BATT.
		72010-709.80		BEDIENUNGSANLEITUNG	INSTRUCTION MANUAL
		75986-435.84		TASCHE	BAG

POS. NR. POS. NO.	SACHNUMMER PART NUMBER	BEZEICHNUNG DESCRIPTION	 
			
CF 1	75987-513.19	KERAMIK-FILTER	
CF 2	75987-201.22	KERAMIKFILTER 10,7MS3	
CF 3	75987-201.22	KERAMIKFILTER 10,7MS3	
CF 4	75987-513.20	KERAMIK-FILTER	
CF 5	75987-513.21	KERAMIK FILTER	
CF 6	75987-515.04	KER.FILTER ST.L.	
			
D1-13	8309-401-683	MELF-DIODE RLS 135 R'OHM	
D14-19	8309-534-148	MELF-DIODE RLS 4148 R'OHM	
D20-33	8309-401-683	MELF-DIODE RLS 135 R'OHM	
D34-40	8309-534-148	MELF-DIODE RLS 4148 R'OHM	
D41-50	8309-401-683	MELF-DIODE RLS 135 R'OHM	

POS. NR. POS. NO.	SACHNUMMER PART NUMBER	BEZEICHNUNG DESCRIPTION	 
D 51	75987-513.41	DIODE SD116	
D 52	75987-451.32	Z DIODE MTZJ 4,7	
D 53	75986-435.11	DIODE KB 262	
D 101	75986-435.12	LE DIODE SLH 34 MT	
			
IC 1	75987-513.33	IC TA 8122 AN	
IC 2	75987-513.34	IC TA 3776 P	
IC 3	75987-513.35	IC LC 7534 M	
IC 4	75987-513.36	IC LA 5003 M	
IC 5	75986-435.07	IC PC 74 HC 154 T	
IC 18	75987-513.38	TRANS. 2 SB 1065 Q	
IC 101	75986-435.06	IC LC 5850-738	

POS. NR.	SACHNUMMER	BEZEICHUNG 
POS. NO.	PART NUMBER	DESCRIPTION 
JK 1	75987-470.26	BUCHSE
JK 2	75978-255.04	ANSCHLUSSBUCHSE/NETZTEIL
		
L 1	75987-513.77	SPULE
L 2	75986-435.28	SPULE
L 3	75986-435.28	SPULE
L 4	75987-513.16	SPULE
L 5	75986-435.36	SPULE
L 6	75986-435.35	SPULE
L 7	75987-513.15	SPULE
L 8	75987-513.15	SPULE
		
PVC 1	75987-513.42	DREHKONDENSATOR 140+82-4R
PVC 2	75986-435.34	DREHKO 140+82-40
		
Q 1-7	75986-435.08	TRANS.2 SA 1162 GR-TE85L
Q 8	75986-435.09	TRANS.2 SC 2712 GR-TE85L
Q 9	75986-435.10	TRANS.2 SC 2712 BL-TE85L
Q 10	75986-403.99	TRANS.2 SB 815 B7-TA
Q 11	75986-435.10	TRANS.2 SC 2712 BL-TE85L
Q 12	75986-435.08	TRANS.2 SA 1162 GR-TE85L
Q 13	75986-435.09	TRANS.2 SC 2712 GR-TE85L
Q 14	75986-404.07	TRANS.2 SD 1048 X7-TA
Q 15	75986-403.99	TRANS.2 SB 815 B7-TA
Q 16	75986-435.10	TRANS.2 SC 2712 BL-TE85L
Q 17	75986-435.08	TRANS.2 SA 1162 GR-TE85L
Q 19	75986-403.99	TRANS.2 SB 815 B7-TA
		
S 1	75987-513.23	SCHALTER/KLANG
S 2	75987-515.05	SCHALTER ST.L.
S 101	75986-435.29	SCHIEBESCHALTER
S 301-309	75986-435.31	TIPPSCHALTER
		
T 1	75986-435.38	SPULE 
T 1	75986-435.85	SPULE 
T 2	75986-435.39	SPULE
T 3	75986-435.40	FILTER
T 4	75986-435.41	SPULE
T 5	75986-435.42	FILTER 
T 5	75986-435.86	FILTER 
T 6	75986-435.43	FILTER
T 7	75986-435.44	FILTER
T 8	75986-435.45	FILTER
T 9	75986-435.46	FILTER
T 10	75986-435.47	FILTER
T 11	75986-435.48	FILTER

ÄNDERUNGEN VORBEHALTEN

POS. NR.	SACHNUMMER	BEZEICHUNG 
POS. NO.	PART NUMBER	DESCRIPTION 
T 12	75986-435.49	SPULE
T 13	75986-435.50	SPULE
T 14	75986-435.14	SPULE 
T 14	75986-435.87	SPULE 
T 15	75986-435.15	FILTER 
T 15	75986-435.88	FILTER 
T 16	75986-435.16	FILTER
T 17	75986-435.17	FILTER
T 18	75986-435.18	FILTER 
T 18	75986-435.89	FILTER 
T 19	75986-435.19	FILTER
T 20	75986-435.20	FILTER
T 21	75986-435.21	SPULE
T 22	75986-435.22	FILTER
T 23	75986-435.23	FILTER
T 24	75986-435.24	FILTER
T 25	75986-435.25	FILTER
T 26	75986-435.26	FILTER
T 27	75987-513.65	SPULE
T 28	75987-513.64	SPULE
T 29	75986-435.37	FILTER
		
XT 101	8382-200-797	SCHWINGQUARZ 32,768 KHZ

ALTERNATIONS RESERVED

Sicherheitsvorschriften / Safety requirements / Prescrizioni de sicurezza / Prescriptions de sécurité / Prescripciones de seguridad

D **Achtung:** Bei Eingriffen ins Gerät sind die Sicherheitsvorschriften nach VDE 701 (reparaturbezogen) bzw. VDE 0860 / IEC 65 (gerätebezogen) zu beachten!

 Bauteile nach IEC- bzw. VDE-Richtlinien! Im Ersatzfall nur Teile mit gleicher Spezifikation verwenden!

MOS - Vorschriften beim Umgang mit MOS - Bauteilen beachten!

GB **Attention:** Please observe the applicable safety requirements according to VDE 701 (concerning repairs) and VDE 0860 / IEC 65 (concerning type of product)!

 Components to IEC or VDE guidelines! Only use components with the same specifications for replacement!

Observe **MOS** components handling instructions when servicing!

I **Attenzione:** Osservare le corrispondenti prescrizioni di sicurezza VDE 701 (concernente servizio) e VDE 0860 / IEC 65 (concernente il tipo di prodotto)!

 Componenti secondo le norme VDE risp. te IEC! In caso di sostituzione impiegare solo componenti con le stesse caratteristiche.

Osservare le relative prescrizioni durante, lavori con componenti **MOS**!

F **Attention:** Priere d'observer les prescriptions de securite VDE 701 (concernant les reparations) et VDE 0860 / IEC 65 (concernant le type de produit)!

D

Sicherheitsbestimmungen

Nach Servicearbeiten ist bei Geräten der Schutzklasse II die Messung des Isolationswiderstandes und des Ableitstromes bei eingeschaltetem Gerät nach VDE 0701 / Teil 200 bzw. der am Aufstellort geltenden Vorschrift, durchzuführen!

Dieses Gerät entspricht der Schutzklasse II, erkennbar durch das Symbol .

• Messen des Isolationswiderstandes nach VDE 0701.

Isolationsmesser ($U_{\text{Test}} = 500 \text{ V-}$) gleichzeitig an beiden Netzpole und zwischen allen Gehäuse- oder Funktionsteilen (Antenne, Buchsen, Tasten, Zerteilen, Schrauben, usw.) aus Metall oder Metallegierungen anlegen. Fehlerfrei ist das Gerät bei einem:

$$R_{\text{isol}} \geq 2 \text{ M}\Omega \text{ bei } U_{\text{Test}} = 500 \text{ V-}$$

Meßzeit: $\geq 1 \text{ s}$ (Fig. 1)

Anmerkung: Bei Geräten der Schutzklasse II kann durch Entladungswiderstände der Meßwert des Isolationswiderstandes konstruktionsbedingt $< 2 \text{ M}\Omega$ sein. In diesen Fällen ist die Ableitstrommessung maßgebend.

Prüfung
Test item
Apparecchio in misura
Pièce d'essai
Aparato de prueba

Netzstecker des Prüflings
Mains plug of test item
Spina di rete dell'apparecchio in misura
Fiche secteur pièce de essai
Clavija de red del aparato de prueba

Fig. 1

Prüfung
Test item
Apparecchio in misura
Pièce d'essai
Aparato de prueba

Netzstecker des Prüflings
Mains plug of test item
Spina di rete dell'apparecchio in misura
Fiche secteur pièce de essai
Clavija de red del aparato de prueba

Fig. 2

 Composants répondant aux normes VDE ou IEC. Les remplacer uniquement par des composants ayant les memes spécifications.

Lors de la manipulation des circuits **MOS**, respecter les prescriptions **MOS**!

E **Atención:** Recomendamos las normas de seguridad VDE u otras normas equivalentes, por ejemplo: VDE 701 para reparaciones, VDE 0860 / IEC 65 para aparatos!

 Componentes que cumplen las normas VDE/IEC. En caso de sustitución, emplear componentes con idénticas especificaciones!

Durante la reparacion observar las normas sobre componentes **MOS**!

USA
U.S. & Canada

Attention: This set can only be operated from AC mains of 120 V/60 Hz. Also observe the information given on the rear of the set.

 CAUTION-for continued protection against risk of fire replace only with same type fuses!

CAUTION: to reduce the risk of electric shock, do not remove cover (or back), no user-serviceable parts inside, refer servicing to qualified service personnel.

 Components to safety guidelines (IEC/U.L.!) Only use components with the same specifications for replacement!

Observe by checking leakage-current or resistance measurement that the exposed parts are acceptably insulated from the supply circuit.

Observe **MOS** components handling instructions when servicing!

• Messen des Ableitstromes nach VDE 0701.

Ableitstrommesser ($U_{\text{Test}} = 220 \text{ V}\approx$) gleichzeitig an beiden Netzpole und zwischen allen Gehäuse- oder Funktionsteilen (Antenne, Buchsen, Tasten, Zerteilen, Schrauben, usw.) aus Metall oder Metallegierungen anlegen. Fehlerfrei ist das Gerät bei einem:

$$I_{\text{Ableit}} \leq 1 \text{ mA bei } U_{\text{Test}} = 220 \text{ V} =$$

Meßzeit: $\geq 1 \text{ s}$ (Fig. 2)

• Wir empfehlen die Messungen mit dem METRATESTER 3 durchzuführen. (Meßgerät zur Prüfung elektrischer Geräte nach VDE 0701).

Metrawatt GmbH
Geschäftsstelle Bayern
Triebstr. 44
D 8000 München 50

• Ist die Sicherheit des Gerätes nicht gegeben, weil
- eine Instandsetzung unmöglich ist
- oder der Wunsch des Benützers besteht, die Instandsetzung nicht durchführen zu lassen, so muß dem Betreiber die vom Gerät ausgehende Gefahr schriftlich mitgeteilt werden.

Mit der Greifklemme alle Metallteile u. metallisierten Teile abtasten.
All metal and metallic parts must be tested with the Caliper clamp.
Con cavo provvisto di morsetto toccare tutte le parti metalliche o metallizzate.

A l'aide d'une pince vérifier toutes les parties métalliques ou métallisées.
Con la pinza, tocar todas las piezas metálicas o metalizadas.

Netzstecker/Mains plug/Spina di rete/Fiche secteur/Clavija de red

Mit der Greifklemme alle Metallteile u. metallisierten Teile abtasten.
All metal and metallic parts must be tested with the Caliper clamp.
Con cavo provvisto di morsetto toccare tutte le parti metalliche o metallizzate.

A l'aide d'une pince vérifier toutes les parties métalliques ou métallisées.
Con la pinza, tocar todas las piezas metálicas o metalizadas.

Netzstecker/Mains plug/Spina di rete/Fiche secteur/Clavija de red

Empfehlungen für den Servicefall

- Nur Original - Ersatzteile verwenden.
Bei Bauteilen oder Baugruppen mit der Sicherheitskennzeichnung Δ sind Original - Ersatzteile zwingend notwendig.
- Auf Sollwert der Sicherungen achten.
- Zur Sicherheit beitragende Teile des Gerätes dürfen weder beschädigt noch offensichtlich ungeeignet sein.
- Dies gilt besonders für Isolierungen und Isolierteile.

GB

Safety Standard Compliance

After service work on a product conforming to the Safety Class II, the insulating resistance and the leakage current with the product switch on must be checked according to VDE 0701 or to the specification valid at the installation location!

This product conforms to the Safety Class II, as identified by the symbol \square .

• Measurement of the Insulation Resistance to VDE 0701,

Connect an Insulation Meter ($U_{\text{Test}} = 500 \text{ V}$ -) to both mains poles simultaneously and between all cabinet or functional parts (antenna, sockets, buttons, decorative parts, etc.) made from metal or metal alloy. The product is fault free if:

$$R_{\text{isol}} \geq 2 \text{ M}\Omega \text{ at } U_{\text{Test}} = 500 \text{ V-}$$

Measuring time: $\geq 1 \text{ s}$, (Fig. 1)

Comment: On product conforming to the Safety class II the Insulation Resistance can be $< 2 \text{ M}\Omega$, dependent constructively on discharge resistors. In this cases, the check of the leakage current is significant.

• Measurement of the Leakage Current to VDE 0701.

Connect the Leakage Current Meter ($U_{\text{Test}} = 220 \text{ V}$ -) to both mains poles simultaneously and between all cabinet or functional parts (antenna, sockets, buttons, screws, etc.) mad from metal or metal alloy. The product is fault free if:

$$I_{\text{Leak}} \leq 1 \text{ mA at } U_{\text{Test}} = 220 \text{ V}$$

Measuring time: $\geq 1 \text{ s}$, (Fig. 2)

- Netzleitungen und Anschlußleitungen sind auf äußere Mängel vor dem Anschluß zu prüfen. Isolation prüfen!
- Die Funktionssicherheit der Zugentlastung und von Biegeschutz-Tüllen ist zu prüfen.
- Thermisch belastete Lötstellen absaugen und neu löten.
- Belüftungen frei lassen.

- We recommend that the measurements are carried out using the **METRATER 3**. (Test equipment for checking electrical products to VDE 0701).

Metrawatt GmbH
Geschäftsstelle Bayern
Triebstr. 44
D 8000 München 50

- If the safety of the product is not proved, because
 - a repair and restoration is impossible
 - or the request of the user is that the restoration is not to be carried out, the operator of the product must be warned of the danger by a written warning.

Recommendation for service repairs

- Use only original spare parts.
With components or assemblies accompanied with the Safety Symbol Δ only original-spare parts are strictly to be used.
- Use only original fuse value.
- Safety compliance, parts of the product must not be visually damaged or unsuitable. This is valid especially for insulators and insulating parts.
- Mains leads and connecting leads should be checked for external damage before connection. Check the insulation!
- The functional safety of the tension relief and bending protection bushes are to be checked:
- Thermally loaded solder pads are to be suck off and re-soldered.
- Ensure that the ventilation slots are not obstructed.

F

Prescriptions de securite

Suite aux travaux de maintenance sur les appareils de la classe II, il convient de mesurer la résistance d'isolement et le courant de fuite sur l'appareil en état de marche, conformément à la norme VDE 0701 § 200, ou selon les prescriptions en vigueur sur le lieu de fonctionnement de l'appareil!

Cet appareil est conforme aux prescriptions de sécurité classe II, signalé par le symbole \square .

• Mesure de la résistance d'isolement selon VDE 0701

Brancher un appareil de mesure d'isolement ($U_{\text{test}} = 500 \text{ V}$ -) simultanément sur les deux pôles secteur et entre toutes les parties métalliques ou métallisées accessibles de l'appareil (antenne, embases, touches, enjoliveurs, vis, etc.).

Le fonctionnement est correct lorsque:

$$R_{\text{isol}} \geq 2 \text{ M}\Omega \text{ pour une } U_{\text{test}} : 500\text{V-}$$

Durée de la mesure: $\geq 1 \text{ s}$

Observations: L'isolement des appareils de la classe II, de part leur conception (résistance de décharge), peut être inférieur à $< 2 \text{ M}\Omega$, (Fig. 1).

• Mesure du courant de fuite selon VDE 0701

Brancher un ampèremètre du courant de fuite ($U_{\text{test}} = 220\text{V}$ -) simultanément sur les deux pôles du secteur et entre toutes les parties métalliques ou métallisées accessibles de l'appareil (antenne, embases, touches, enjoliveurs, vis, etc.). Le fonctionnement est correct lorsque (Fig. 2):

$$I_{\text{fuite}} \leq 1 \text{ mA pour } U_{\text{test}} : 220 \text{ V}$$

Durée de la mesure $\geq 1 \text{ s}$.

- Pour ces mesures, nous préconisons l'utilisation du **METRATER 3** (instrument de mesure pour le contrôle d'appareils électriques conformes à la norme VDE 0701).

Metrawatt GmbH
Geschäftsstelle Bayern
Triebstr. 44
D 8000 München 50

- Dans le cas où la sécurité de l'appareil n'est pas assurée pour les raisons suivantes:
 - la remise en état est impossible
 - l'utilisateur ne souhaite pas la remise en état de l'appareil, l'utilisateur doit être informé par écrit du danger que représente l'utilisation de l'appareil.

Recommandations pour la maintenance

- Utiliser exclusivement des pièces de rechange d'origine. Les composants et ensembles de composants signalés par le symbole Δ doivent être impérativement remplacés par des pièces d'origine.
- Respecter la valeur nominale des fusibles.
- Veiller au bon état et la conformité des pièces contribuant à la sécurité de fonctionnement de l'appareil. Ceci s'applique particulièrement aux isolements et pièces isolantes.
- Vérifier le bon état extérieur des câbles secteur et des câbles de raccordement au point de vue isolement avant la mise sous tension.
- Vérifier le bon état des protections de gaine.
- Nettoyer les soudures avant de les renouveler.
- Dégager les voies d'aération.

I

Norme di sicurezza

Successivamente ai lavori di riparazione, negli apparecchi della classe di protezione II occorre effettuare la misura della resistenza di isolamento e della corrente di dispersione quando l'apparecchio è acceso, secondo le norme VDE 0701 / parte 200 e rispettivamente le norme locali!

Questo apparecchio corrisponde alla classe di protezione II ed è riconoscibile dal simbolo \square .

• Misura della resistenza di isolamento secondo VDE 0701

Applicare il misuratore di isolamento (tens. prova = 500 V-) contemporaneamente ai due poli di rete e tra tutte le parti del mobile e delle funzioni (antenna, prese, tasti, mascherine, viti ecc.) in metallo o in lega metallica. L'apparecchio non presenta difetti quando:

$$R_{\text{isol}} \geq 2 \text{ M}\Omega \text{ con tens. prova} = 500 \text{ V-}$$

Tempo di misura: $\geq 1 \text{ s}$ (Fig. 1).

Nota: Negli apparecchi della classe II, che per motivi costruttivi dispongono di resistenze di dispersione, il valore di misura della resistenza di isolamento può essere inferiore a $< 2 \text{ M}\Omega$.

In questi casi è determinante la misura della corrente di dispersione.

• Misura della corrente di dispersione secondo VDE 0701

Applicare il misuratore di isolamento (tens. prova = 220 V-) contemporaneamente ai due poli di rete e tra tutte le parti del mobile e delle funzioni (antenna, prese, tasti, mascherine, viti ecc.) in metallo o in lega metallica. L'apparecchio non presenta difetti quando:

$$I_{\text{disp.}} \leq 1 \text{ mA con tens. prova} = 220 \text{ V}$$

Tempo di misura : $\geq 1 \text{ s}$ (Fig. 2)

E

DISPOSICIONES PARA LA SEGURIDAD

Después de operaciones de servicio en aparatos de la clase de protección II, se llevará a cabo la medida de la resistencia de aislamiento y de la corriente derivada, con el aparato conectado, de acuerdo con VDE 0701 o de las disposiciones vigentes en el lugar de instalación.

Este aparato corresponde a la clase de protección II, reconocible por el símbolo \square .

• Medida de la resistencia de aislamiento según VDE 0701.

Aplicar el medidor de aislamiento ($U_{\text{prueba}} = 500 \text{ V-}$), simultáneamente, a los dos polos de red y entre todas las partes del mueble o de funciones (antena, conectores, teclas, tornillos, etc.) de metal o aleaciones metálicas. El aparato estará libre de defectos con:

$$R_{\text{aisl}} \geq 2 \text{ M}\Omega \text{ con } U_{\text{prueba}} = 500 \text{ V-}$$

Tiempo de medida $\geq 1 \text{ seg}$.

Observación: En aparatos de la clase de protección II, condicionado por la construcción y por resistencias de descarga, el valor de medida de la resistencia de aislamiento puede ser superior a $< 2 \text{ M}\Omega$.

En este caso es decisiva la medida de la corriente derivada (Fig. 1).

• Medida de la corriente derivada de acuerdo con VDE 0701.

Aplicar el medidor de corriente derivada ($U_{\text{prueba}} = 220 \text{ V}$ -) simultáneamente a los dos polos de red y entre todas las partes del mueble o de funciones (antena, conectores, teclas, tornillos, etc.) de metal o aleaciones metálicas. El aparato estará libre de defectos con (Fig. 2):

$$I_{\text{deriv}} \leq 1 \text{ mA con } U_{\text{prueba}} = 220 \text{ V}$$

Tiempo de medida : $\geq 1 \text{ seg}$.

- Si si raccomanda di effettuare le misure con lo strumento **METRATER 3** (strumento di misura per il controllo di apparecchi elettrici secondo VDE 0701).

Metrawatt GmbH
Geschäftsstelle Bayern
Triebstr. 44
D 8000 München 50

- Se la sicurezza dell'apparecchio non è raggiunta, perché
 - una riparazione non è possibile
 - oppure è desiderio del cliente che una riparaz. non avvenga in questi casi si deve comunicare per iscritto all'utilizzat. la pericolosità dell'apparecchio riguardo il suo isolamento.

Raccomandazione per il servizio assistenza

- Impiegare solo componenti originali:
 - I componenti o i gruppi di componenti contraddistinti dall' indicaz. Δ devono assolutamente venir sostituiti con parti originale.
- Osservare il valore nominale dei fusibili.
- I componenti che concorrono alla sicurezza dell'apparecchio non possono essere nè danneggiati nè risultare visibilmente inadatti. Questo vale soprattutto per isolamenti e parti isolate.
- I cavi di rete e di collegamento vanno controllati prima dell'utilizzo affinché non presentino imperfezioni esteriori. Controllare l'isolamento.
- E' necessario controllare la sicurezza dei fermacavi e delle guaine flessibili.
- Saldature caricate termicam. vanno rifatte.
- Lasciare libere le fessure di areazione.

- Aconsejamos llevar a cabo las medidas con el **METRATER 3** (Instrumento de medida para la comprobación de aparatos eléctricos según VDE 0701).

Metrawatt GmbH
Geschäftsstelle Bayern
Triebstr. 44
D 8000 München 50

- Si no se cumple la seguridad del aparato, poroue
 - la puesta en orden es imposible, o
 - existe el desco del usuario de no realizarla, se ha de comunicar a quien lo haga funcionar, por escrito, del peligro dimanante del aparato.

Recomendaciones para caso de servicio

- Emplear sólo componentes originales.
Con componentes o grupos constructivos con el indicativo de seguridad Δ son de obligada neccsidad piezas de repuesto originales.
- Las vartes del aparato que contribuyan a la seguridad del mismo no deben estar deterioradas ni ser manifiestamente inadecuadas.
- Esto es especialmente válido para aislamientos o piezas aislantes.
- Los cables de red y de conexión se comprobarán, antes de conectarlos, en cuanto a defectos externos. Comprobar el aislamiento.
- Se ha de comprobar la función de seguridad de la compensación de tiro o de los manguitos de protección contra doblamientos.
- Reparar los puntos de soldadura sometidos a carga térmica.
- Mantener libres los canales aireación.

Safety Instructions

The lightning flash with arrowhead symbol, within an equilateral triangle, is intended to alert the user to the presence of uninsulated "dangerous voltage", within the product's enclosure that may be of sufficient magnitude to constitute a risk of electric shock to persons.

The exclamation point within an equilateral triangles is intended to alert the user to the presence of important operating and maintenance (servicing) instructions in the literature accompanying the appliance.

This product was designed and manufactured to meet strict quality and safety standards. There are, however, some installation and operation precautions which you should be particularly aware of.

- Read Instructions - All the safety and operating instructions should be read before the appliance is operated.
- Retain Instructions - The safety and operating instructions should be retained for future reference.
- Heed Warnings - All warnings on the appliance and in the operating instructions should be adhered to.
- Follow Instructions - All operating and use instructions should be followed.
- Water and Moisture - The appliance should not be used near water-for example, near a bathtub, washbowl, kitchen sink, laundry tub, in a wet basement, or near a swimming pool, and the like.
- Wall or Ceiling Mounting - The appliance should be mounted to wall or ceiling only as recommended by the manufacturer.
- Ventilation - The appliance should be situated so that its location or position does not interfere with its proper ventilation. For example, the appliance should not be situated on a bed, sofa, rug, or similar surface that may block the ventilation openings; or, placed in a built-in installation, such as a bookcase or cabinet that may impede the flow of air through the ventilation openings.
- Heat - The appliance should be situated away from heat sources such as radiators, heat registers, stoves, or other appliances (including amplifiers) that produce heat.

- Power Sources - The appliance should be connected to a power supply only of the type given above or as marked on the appliance.
 - Power-Cord Protection - Power-supply cords should be routed so that they are not likely to be walked on or pinched by items placed upon or against them, paying particular attention to cords at plugs, convenience receptacles, and the point where they exit from the appliance.
 - Cleaning - The appliance should be cleaned only as recommended by the manufacturer.
 - Power Lines - An outdoor antenna should be located away from power lines.
 - Outdoor Antenna Grounding - If an outside antenna is connected to the receiver, be sure the antenna system is grounded so as to provide some protection against voltage surges and built up static charges. Section 810 of the National Electrical Code, ANSI / NFPA No. 70-1984, provides information with respect to proper grounding of the mast and supporting structure, grounding of the lead-in wire to an antenna discharge unit, size of grounding conductors, location of antenna discharge unit, connection to grounding electrodes, and requirements for the grounding electrode.
 - Nonuse Periods - The power cord of the appliance should be unplugged from the outlet when left unused for a long period of time.
 - Object and Liquid Entry - Care should be taken so that objects do not fall and liquids are not spilled into the enclosure through openings.
 - Damage Requiring Service - The appliance should be serviced by qualified service personnel when: The power-supply cord or the plug has been damaged; or objects have fallen, or liquid has been spilled into the appliance; or the appliance has been exposed to rain; or the appliance does not appear to operate normally or exhibits a marked change in performance; or the appliance has been dropped, or the enclosure damaged; or the batteries have been damaged.
 - Servicing - the user should not attempt to service the appliance beyond that described in the operating instructions. All other servicing should be referred to qualified service personnel.
- Points x1 and x2 apply only to receivers or tuners.

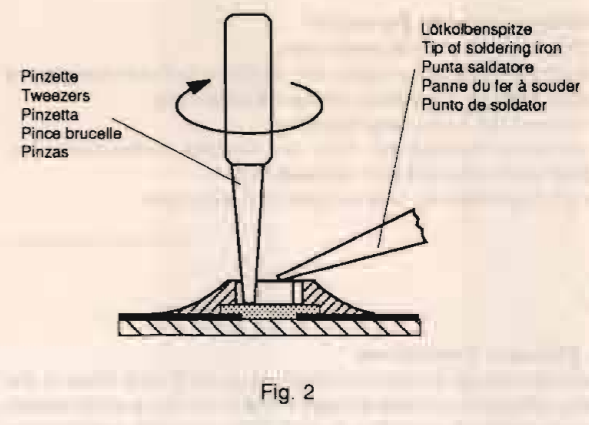
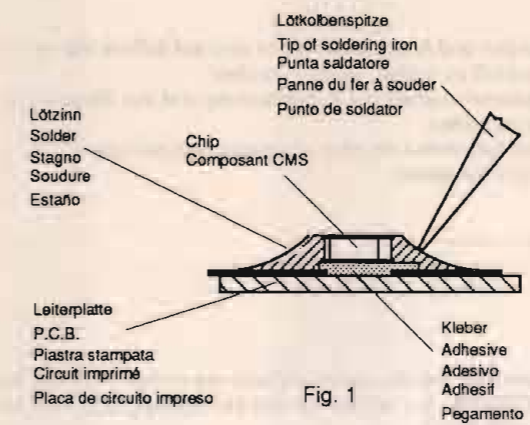

F Technologie CMS

- Soudure des composants CMS**
- Utiliser exclusivement un fer à souder à basse tension et réglage thermique
 - La température de soudure doit être de 240 °C environ (max. 300 °C)
 - L'opération doit être très brève.
 - Conserver les composants CMS dans leur emballage d'origine jusqu'au moment de leur utilisation, ceci pour éviter l'oxydation des contacts externes.
 - Ne pas toucher les composants CMS à la main nue.

- Dessoudage des composants CMS**
1. Aspirer la soudure du composant CMS à la l'aide de la tresse à souder (Fig. 1).
 2. Chauffer légèrement les contacts externes du composant CMS ou le composant lui-même. Retirer ce dernier avec précaution en le tournant afin d'éviter un arrachement des circuits imprimés situés sous le composant (Fig. 2).

Attention! Ne pas réutiliser les composants CMS, la face conductrice pouvant être endommagée.

- Soudure des composants CMS**
3. Aspirer les restes de soudure sur le circuit. Poser une pointe de soudure (Fig. 3).
 4. Poser le composant CMS sur cette pointe de soudure, centrer et souder. Maintenir le composant CMS à l'aide d'une pince brucelle (Fig. 4).
 5. Effectuer la même opération pour l'autre côté. Terminer la première soudure (Fig. 5).

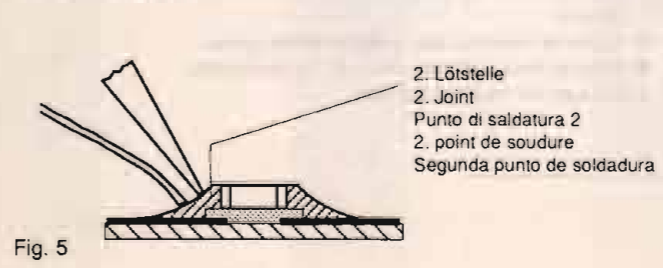
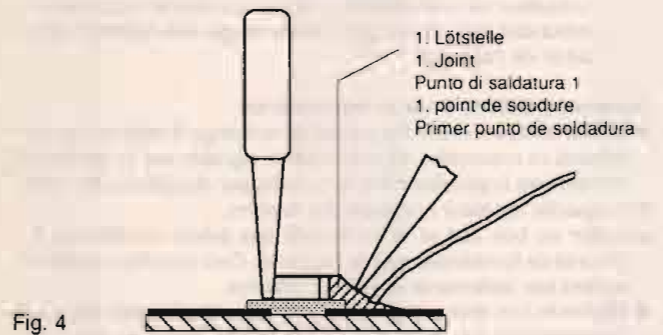
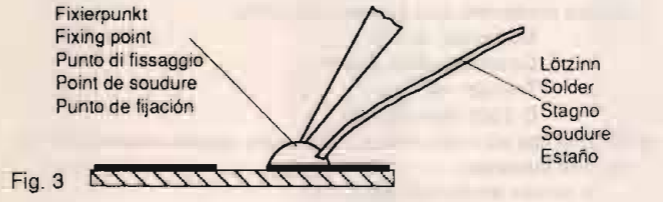

I Tecnica CHIP

- Saldatura e dissaldatura di componenti MOS**
- Impiegare un saldatore a basso voltaggio con regolazione della temperatura.
 - Temperatura del saldatore: ca. 240 °C (valore massimo 300 °C).
 - Il tempo di saldatura deve essere il più breve possibile.
 - Il componente CHIP deve rimanere nell'imballaggio originale fino al momento del suo impiego per evitare che le superfici di contatto si ossidino.
 - Non toccare i componenti CHIP con mani nude.

- Dissaldatura di un CHIP**
1. Aspirare i punti di saldatura del CHIP con una calza dissaldante (Fig. 1).
 2. Riscaldare le superfici di contatto del CHIP risp. te tutto il CHIP e staccarlo con cautela. Attenzione a non esercitare forza per non danneggiare le piste sottostanti (Fig. 2).

Attenzione! Non impiegare più il CHIP dissaldato, perchè il corpo elettrico può presentare delle rotture.

- Saldatura di un CHIP**
3. Pulire il punto dai residui di saldatura. Applicare una goccia di stagno (Fig. 3).
 4. Appoggiare il CHIP sul punto di saldatura, centrarlo e quindi saldarlo (Fig. 4).
 5. Saldare la superfici di contatto libera e, dopo che questa si è raffreddata, saldare nuovamente la superfici opposta (Fig. 5).

E Técnica de CHIP's

- Soldaje y desoldaje de CHIP's**
- Emplear sólo un soldador de bajo voltaje con regulación de temperatura.
 - La temperatura del soldador debe ser de aprox. 240 °C (máx. 300 °C).
 - El tiempo de soldadura debe de ser lo más corto posible.
 - Dejar los componentes CHIP hasta su montaje en el embalaje original. Con ello se evita la oxidación de los contactos frontales.
 - No tocar con las manos los componentes CHIP.

- Desoldaje de un CHIP**
- Primer paso: Aspirar el estaño del punto de soldadura con un aspirador de los tipos de pera o de resorte (Fig. 1).
- Segundo paso: Calentar los extremos o todo el CHIP y girarlo con las pinzas. No hacer fuerza para que la placa de circuito impreso no resulte dañada. Cuidar de que las pistas situadas debajo del CHIP no se suelten de la placa, ya que éstas también están pegadas (Fig. 2).

Ciudad! No volver a utilizar el CHIP desoldado. La capa eléctrica puede estar interrumpida.

- Soldadura de CHIP's**
- Tercer paso: Limpiar el punto de soldadura de residuos de la soldadura anterior. Poner una gota de estaño (Fig. 3).
- Cuarto paso: Colocar el CHIP sobre la gota de estaño, centrarlo y soldarlo (Fig. 4).
- Quinto paso: Soldar la parte libre y, después enfriarse, soldar también la parte opuesta (Fig. 5).

D CHIP Technik

- Aus- und Einlöten von CHIP-Bauteilen**
- Verwenden Sie nur einen NiedervolltötKolben mit Temperaturregelung.
 - Die Löttemperatur sollte ca. 240 °C betragen (max. 300 °C).
 - Halten Sie die Lötzeit so kurz wie möglich.
 - Belassen Sie CHIP-Bauteile bis zur Bearbeitung in der Originalverpackung. Damit wird die Oxidation der Stirnkontakte vermieden.
 - Berühren Sie CHIP-Bauteile nicht mit der bloßen Hand.

- Auslöten von CHIP-Bauteilen**
1. Schritt: CHIP- Lötstelle mit Sauglötze absaugen (Fig. 1).
 2. Schritt: CHIP-Enden, bzw. das komplette CHIP-Bauteil erwärmen. CHIP von der Klebung ohne Kraftaufwand abdrehen, damit unter dem CHIP liegende Leiterbahnen nicht abgerissen werden (Fig. 2).

Achtung! Ausgelötetes CHIP nicht wiederverwenden! Die leitende Schicht kann ausgebrochen sein.

- Einlöten von CHIP-Bauteilen**
3. Schritt: Lötspitze von Lötückständen säubern. Lötperle anbringen (Fig. 3).
 4. Schritt: CHIP an der Lötstelle ansetzen, zentrieren und anlöten (Fig. 4).
 5. Schritt: Freie Seite löten. Nach dem Erkalten die erste Lötstelle nochmals nachlöten (Fig. 5).

GB U.S. & Canada CHIP Technology

- Soldering and unsoldering of CHIP components**
- Use only low-voltage soldering irons with temperature control.
 - Permissible soldering temperatures are approx. 240 °C up to max. 300 °C.
 - Keep the soldering period as short as possible.
 - Keep the CHIP components in their original packages until they are used to avoid oxidation of the end contacts.
 - Do not touch CHIP components with bare hands.

- Unsoldering of CHIP components**
1. step: Clean the CHIP soldering point with a solder wick (Fig. 1).
 2. step: Warm up the ends of the CHIP or the whole CHIP component and remove the CHIP from the adhesive by turning it without application of force so that the tracks beneath the CHIP do not break (Fig. 2).

Attention! Do not use unsoldered CHIPS any more! The conductive layer may be broken.

- Soldering of CHIP components**
3. step: Remove possible residues from the soldering point. Then apply a solder bead (Fig. 3).
 4. step: Put the CHIP onto the soldering point, then center and fix it (Fig. 4).
 5. step: Solder the free end of the CHIP and resolder the first soldering point after it has cooled (Fig. 5).

Abgleich YB 230 Italia/ Alignment YB 230 Italia/ Aligneamento YB 230 Italia/ Taratura YB 230 Italia/ Ajuste YB 230 Italia

Vorbereitung
- µC-Platte ausbauen, Steckverbindungen jedoch nicht abziehen.
(Siehe Ausbauhinweise)

Preparation
- Remove the µC-Board, but don't disconnect the plug-in connector.
(Look for the disassembly instructions)

Abgleich der Filter, die hinter den Zahnrädern (61,62) angeordnet sind
- 2 Schrauben (28) heraus-schrauben.
- Mit "Tuning"-Knopf Abgleichfrequenz einstellen und dann die Zahnräder abnehmen.

Alignment of the filters which are arranged behind the gears (61,62).
- Unscrew two screws (28).
- Tune the alignment frequency by the tuning knob and then take off the gears.

Vor Abgleich der SW-Bänder 2-13 muß sichergestellt sein, daß der Abgleich SW1 richtig durchgeführt wurde!

Before adjusting the SW bands 2-13, it must be sure that the SW1 has already been adjusted.

D GB F I E

• Abgleich • Alignment • Taratura • Ajuste	• Einspeisung • Feeding • Injection • Alimentazione • Aplicación de señal	• Meßpunkt • Testpoint • Point de mesure • Punto di misura • Punto de medida	• Hinweise • Notés • Observation • Note • Advertencias	• Band • Band • Bande • Gamma • Banda	f	• Abgleichpunkt • Alignment point • Point d'alignement • Punto di taratura • Punto de ajuste	• Einstellung • Adjustment • Réglage • Regolazione • Ajuste
• Oszillator und Vorkreis • Oscillator and r.f.circuit • Oscillateur et Circuits préliminaire • Oscillatore ed Circuito ingresso • Oscilador e Circuitos de antena				SW1	3850 kHz	T14	• Maximum • Maximum • Maximum • Massimo • Máximo
					≥4340 kHz	VT2D	
					4100 kHz	VT2C T1	
				SW2	4250 kHz	T15	• Maximum • Maximum • Maximum • Massimo • Máximo
					4550 kHz	T2	
				SW3	4700 kHz	T16	• Maximum • Maximum • Maximum • Massimo • Máximo
					4900 kHz	T3	
				SW4	5750 kHz	T17	• Maximum • Maximum • Maximum • Massimo • Máximo
					6000 kHz	T4	
				SW5	6150 kHz	T18	• Maximum • Maximum • Maximum • Massimo • Máximo
					6500 kHz	T5	
				SW6	7050 kHz	T19	• Maximum • Maximum • Maximum • Massimo • Máximo
					7300 kHz	T6	
				SW7	9400 kHz	T20	• Maximum • Maximum • Maximum • Massimo • Máximo
					9700 kHz	T7	
				SW8	11550 kHz	T21	• Maximum • Maximum • Maximum • Massimo • Máximo
					11800 kHz	T8	
				SW9	13500 kHz	T22	• Maximum • Maximum • Maximum • Massimo • Máximo
13700 kHz	T9						

Abgleich YB 230/ Alignment YB 230/ Aligneamento YB 230/ Taratura YB 230/ Ajuste YB 230

Vorbereitung
- µC-Platte ausbauen, Steckverbindungen jedoch nicht abziehen.
(Siehe Ausbauhinweise)

Preparation
- Remove the µC-Board, but don't disconnect the plug-in connector.
(Look for the disassembly instructions)

Abgleich der Filter, die hinter den Zahnrädern (61,62) angeordnet sind
- 2 Schrauben (28) heraus-schrauben.
- Mit "Tuning"-Knopf Abgleichfrequenz einstellen und dann die Zahnräder abnehmen.

Alignment of the filters which are arranged behind the gears (61,62).
- Unscrew two screws (28).
- Tune the alignment frequency by the tuning knob and then take off the gears.

Vor Abgleich der SW-Bänder 2-13 muß sichergestellt sein, daß der Abgleich SW1 richtig durchgeführt wurde!

Before adjusting the SW bands 2-13, it must be sure that the SW1 has already been adjusted.

D GB F I E

• Abgleich • Alignment • Taratura • Ajuste	• Einspeisung • Feeding • Injection • Alimentazione • Aplicación de señal	• Meßpunkt • Testpoint • Point de mesure • Punto di misura • Punto de medida	• Hinweise • Notes • Observation • Note • Advertencias	• Band • Band • Bande • Gamma • Banda	f	• Abgleichpunkt • Alignment point • Point d'alignement • Punto di taratura • Punto de ajuste	• Einstellung • Adjustment • Réglage • Regolazione • Ajuste
• Oszillator und Vorkreis • Oscillator and r.f.circuit • Oscillateur et Circuits préliminaire • Oscillatore ed Circuito ingresso • Oscilador e Circuitos de antena				SW1	2250 kHz	T14	• Maximum • Maximum • Maximum • Massimo • Máximo
					≥2550 kHz	VT2D	
					2400 kHz	VT2C T1	
				SW2	3150 kHz	T15	• Maximum • Maximum • Maximum • Massimo • Máximo
					3300 kHz	T2	
				SW3	3850 kHz	T16	• Maximum • Maximum • Maximum • Massimo • Máximo
					3950 kHz	T3	
				SW4	9420 kHz	T17	• Maximum • Maximum • Maximum • Massimo • Máximo
					4700 kHz	T4	
				SW5	5750 kHz	T18	• Maximum • Maximum • Maximum • Massimo • Máximo
					6000 kHz	T5	
				SW6	7050 kHz	T19	• Maximum • Maximum • Maximum • Massimo • Máximo
					7300 kHz	T6	
				SW7	9400 kHz	T20	• Maximum • Maximum • Maximum • Massimo • Máximo
					9700 kHz	T7	
				SW8	11550 kHz	T21	• Maximum • Maximum • Maximum • Massimo • Máximo
					11800 kHz	T8	
				SW9	13500 kHz	T22	• Maximum • Maximum • Maximum • Massimo • Máximo
13700 kHz	T9						

• Abgleich • Alignment • Taratura • Ajuste	• Einspeisung • Feeding • Injection • Alimentatione • Aplicación de señal	• Meßpunkt • Testpoint • Point de mesure • Punto di misura • Punto de medida	• Hinweise • Notes • Observation • Note • Advertencias	• Band • Band • Bande • Gamma • Banda	f	• Abgleichpunkt • Alignment point • Point d'alignement • Punto di taratura • Punto de ajuste	• Einstellung • Adjustment • Réglage • Regolazione • Ajuste
• Oszillator und Vorkreis • Oscillator and r.f.circuit • Oscillateur et Circuits préliminaire • Oscillatore ed Circuito ingresso • Oscilador e Circuitos de antena	<p>12 pF $f_{mod} = 1 \text{ kHz}$</p>			SW10	14950 kHz	T 23	• Maximum • Maximum • Maximum • Massimo • Máximo
					15300 kHz	T10	
				SW11	17400 kHz	T24	• Maximum • Maximum • Maximum • Massimo • Máximo
					17700 kHz	T11	
				SW12	21300 kHz	T25	• Maximum • Maximum • Maximum • Massimo • Máximo
					21600 kHz	T12	
SW13	25320 kHz	T26	• Maximum • Maximum • Maximum • Massimo • Máximo				
	25900 kHz	T13					
• Oszillator und Vorkreis • Oscillator and r.f.circuit • Oscillateur et Circuits préliminaire • Oscillatore ed Circuito ingresso • Oscilador e Circuitos de antena	<p>$f_{mod} = 1 \text{ kHz}$</p>			LW	135 kHz	T28	max. ↑↓
					295 kHz	VT2B	max. ↑↓
					170 kHz	L 10	max. ↑↓
					270 kHz	VT2A	max. ↑↓
				MW	510 kHz	T 27	max. ↑↓
					1650 kHz	VT1B	max. ↑↓
					600 kHz	L 9	max. ↑↓
					1400 kHz	VT1A	max. ↑↓
				FM	87,5 MHz	L 6	max. ↑↓
					108 MHz	VT1D	max. ↑↓
88 MHz	L 5	max. ↑↓					
106 MHz	VT1C	max. ↑↓					
• ZF • IF • FI • FI • FI	• Abgleich nach Rauschen • Alignment by noise • Réglage au maximum de bruit • Taratura in base al fruscio • Ajuste según el ruido			MW		T 29	max.

Zeichen- erklärung	Meßsender/Testgenerator Générateur/Generatore di misura Generador frecuencias	NF-Voltmeter/AF-Voltmeter Voltmètre BF/Voltmetro BF Voltmetro de BF
Legende	Antenne/Aerial Cadre/Antenna Antena	Rahmenantenne/Frame aerial Cadre/Antenna a telaio Antena de cuadro
Légende		
Simbologia	"TUNING" nach rechts drehen Turn "TUNING" right Tourner "TUNING" vers la droite Ruotare "TUNING" verso destra Girar "TUNING" a la derecha	"TUNING" nach links drehen Turn "TUNING" left Tourner "TUNING" vers la gauche Ruotare "TUNING" verso sinistra Girar "TUNING" a la izquierda
Aclaración	Einstellung wiederholen/To repeat the adjustment Répéter le réglage/Ripetere la regolazione Repetir el ajuste	

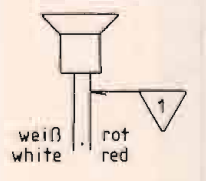
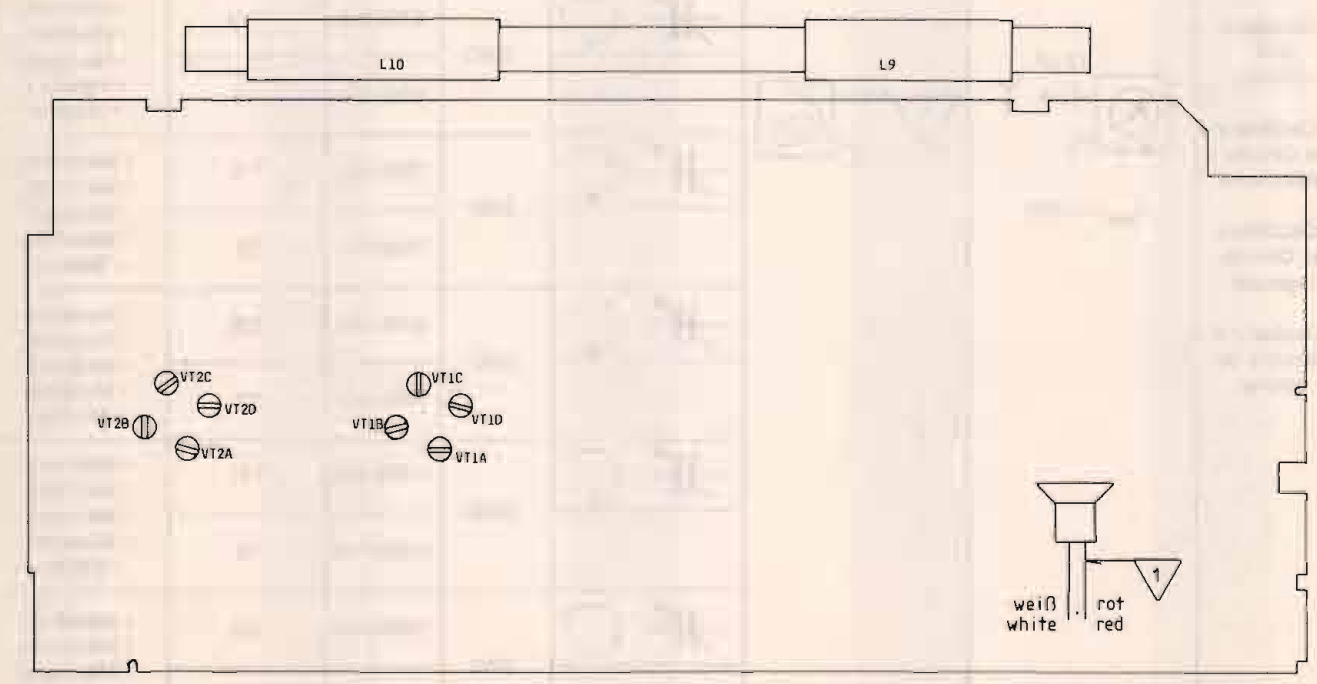
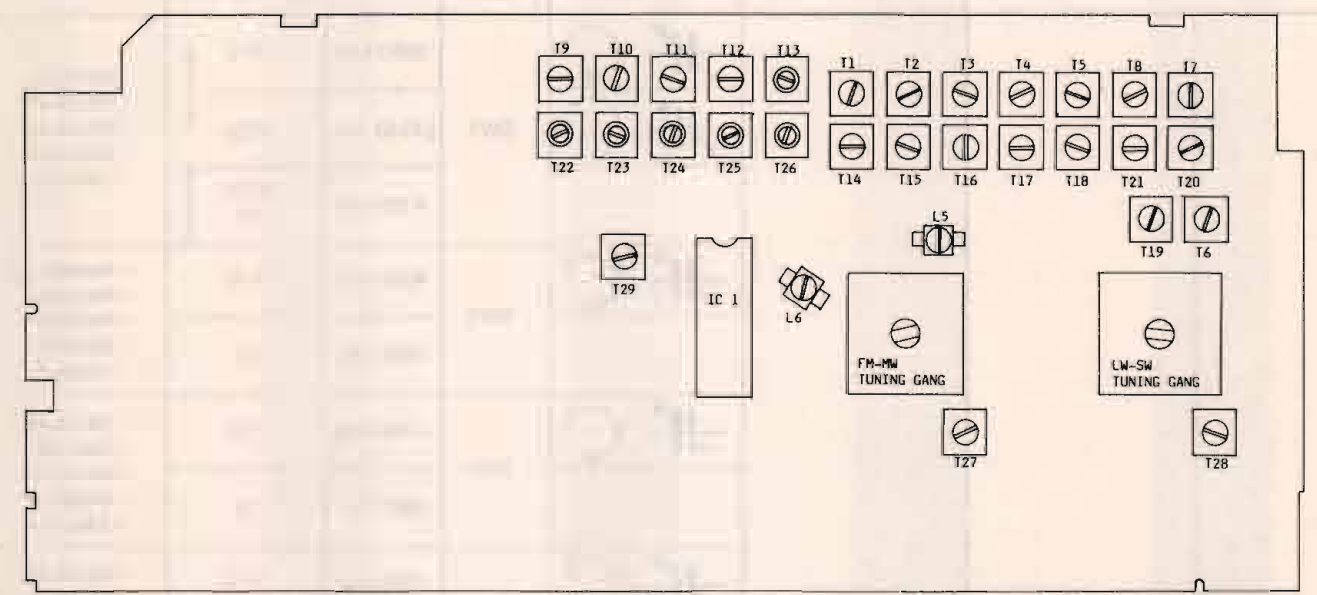

Druckplatten
Printed Circuit Boards

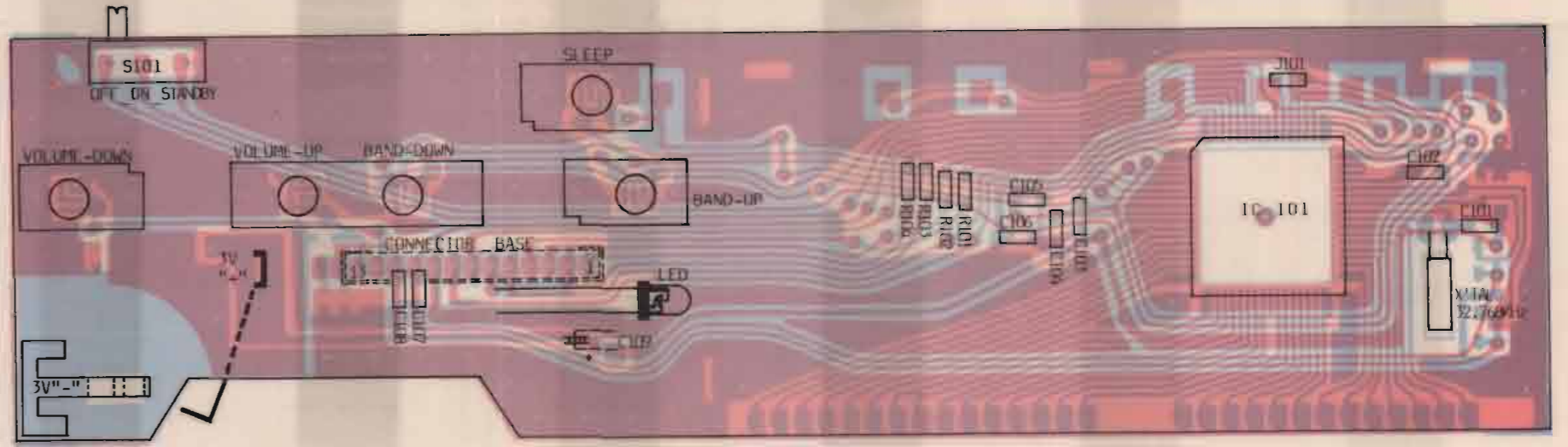
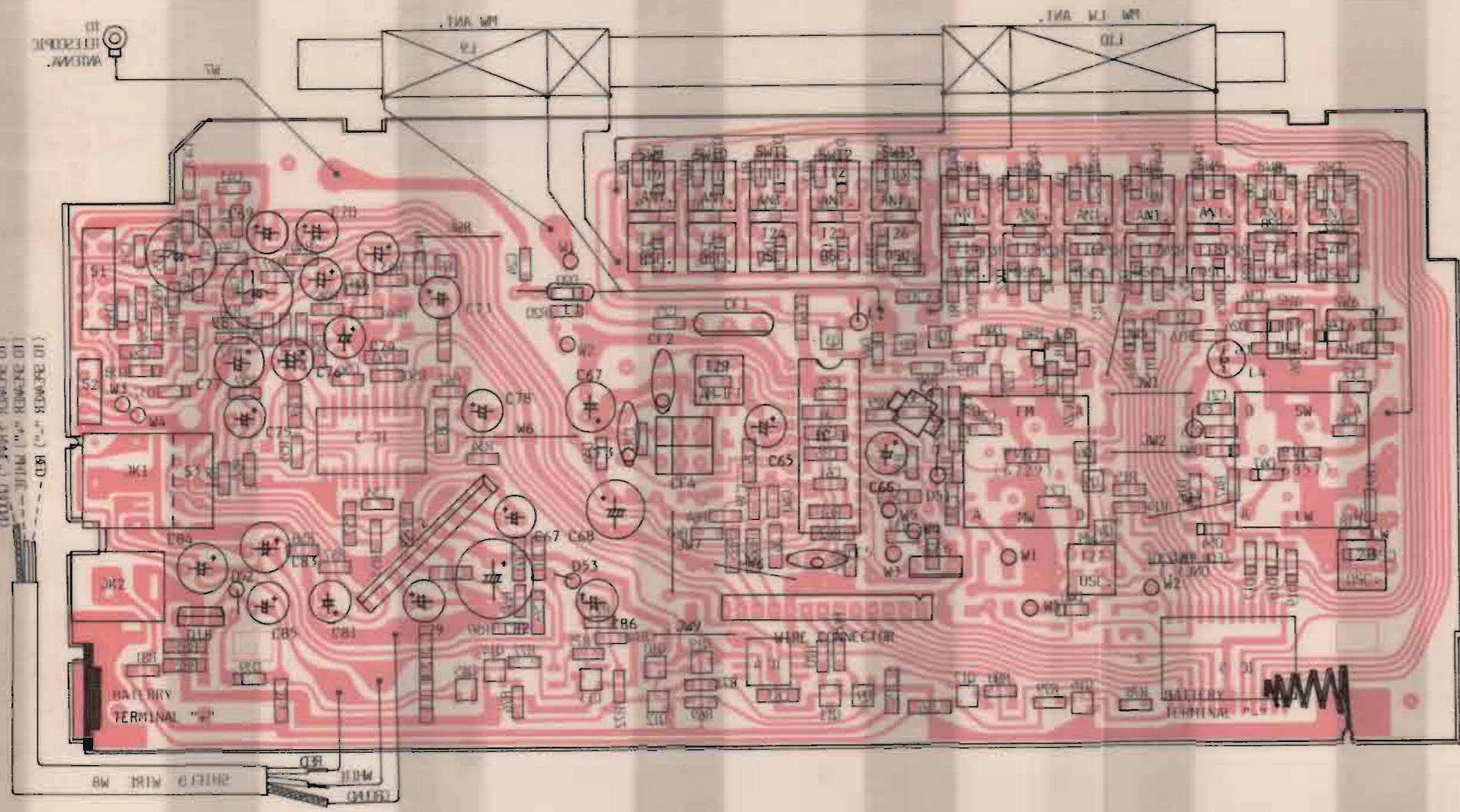

Schaltbild
Connection Diagram

Spannungen in V / Voltages in V

IC 101	
1	0
2-3	-
4	0,7
5	2,1
6	3/0
7	3/0
8	2
9	2,2
10	3 Vss
11-23	3 Vss
24	-
25-36	3 Vss
37	3 Vss
38	3 Vss
39	0
40	3
41	1,4
42	1,4
43	0
44	3/0
45	3/0
46	0
47	0
48-51	Tab.B
52	3/0
53	0
54	0
55	0
56-57	-
58-62	3
63-64	0

IC 101	48	49	50	51
FM	0	0	0	0
LW	0	0	0	3
MW	0	0	3	0
SW1	0	0	3	3
SW2	0	3	0	0
SW3	0	3	0	3
SW4	0	3	3	0
SW5	0	3	3	3
SW6	3	0	0	0
SW7	3	0	0	3
SW8	3	0	3	0
SW9	3	0	3	3
SW10	3	3	0	0
SW11	3	3	0	3
SW12	3	3	3	0
SW13	3	3	3	3

IC 1	1	2	3	4	5	6	7	8	9	10	11	12	13	14	15	16	17	18	19	20	21	22	23	24
FM	0,7	0	0,9	0,9	1,1	2,1	2,1	2,1	0	0	0	1,4	0,3	0,9	1,5	1	1,3	0,6	1,6	2	2	2,1	2,1	1
AM	0	0	1,5	1,5	0,9	2,1	2,1	2,1	0	0	0	2,1	0,9	0,9	1,7	2,3	2	0,6	1	2,2	2,2	2,1	2,2	2,2
IC2	0	0,6	1,8	4,3	0	1,9	1,2	0,6	0	0	2,2	2,2	2,2	2,2	3,6	0	3,7	0	3,7	0				
IC3	0	0	3,7	2,8	2,2	2,2	2,2	0	0	0	2,2	2,2	2,2	2,2	3,6	0	3,7	0	3,7	0				
IC4	0	2,8	-	4	-	-	4,3	0																
IC5	3/0 FM	3/0 LW	3/0 MW	3/0SW1	3/0SW2	3/0SW3	3/0SW4	3/0SW5	3/0SW6	3/0SW7	3/0SW8	0	3/0SW9	3/0SW10	3/0SW11	3/0SW12	3/0SW13	0	0	SIEHE IC 101	PIN 48	-51	3	

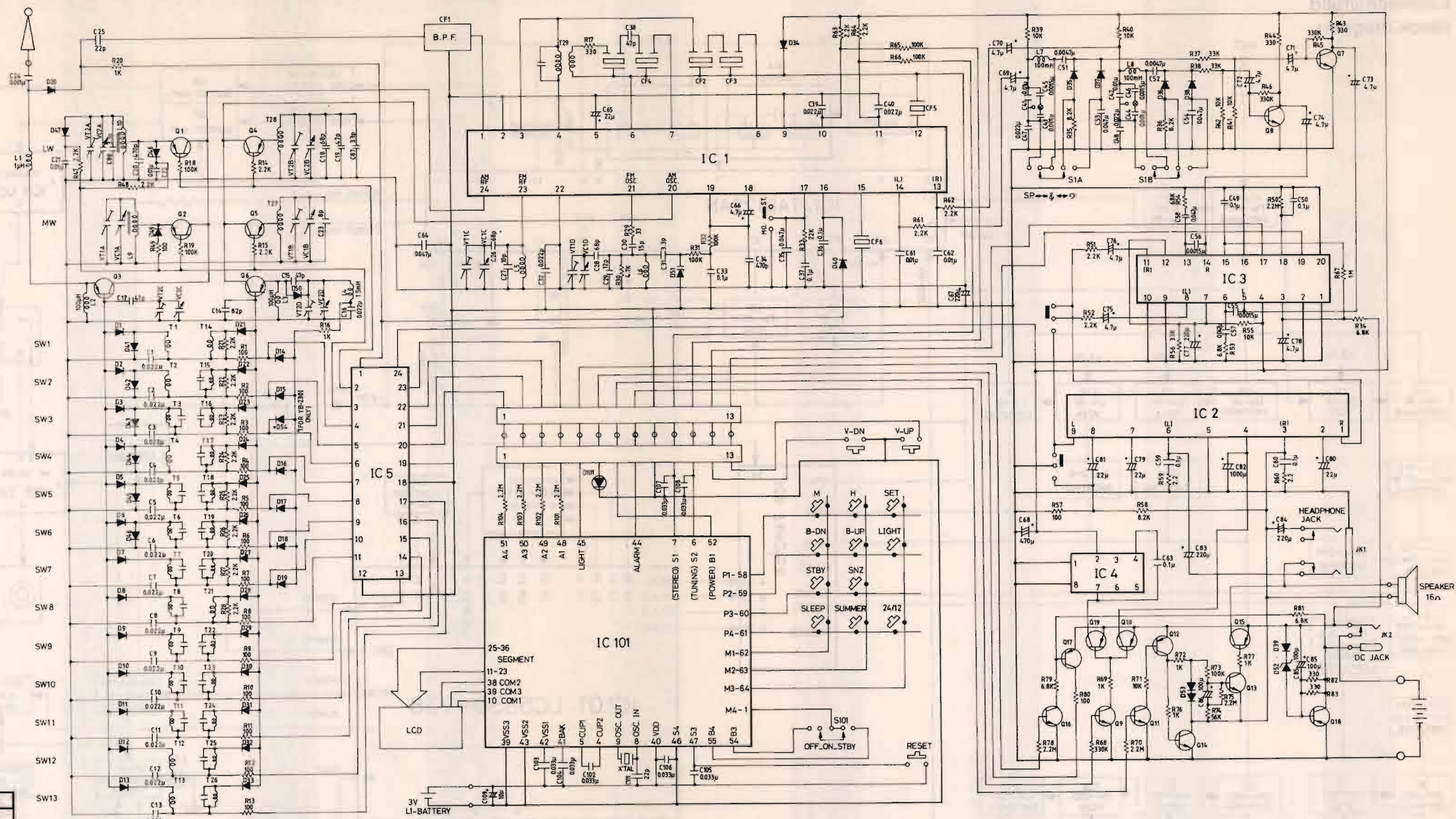

GRUNDIG
Yacht Boy 230
Yacht Boy 230 Italia

**Blockschaltbild
Block Diagram**

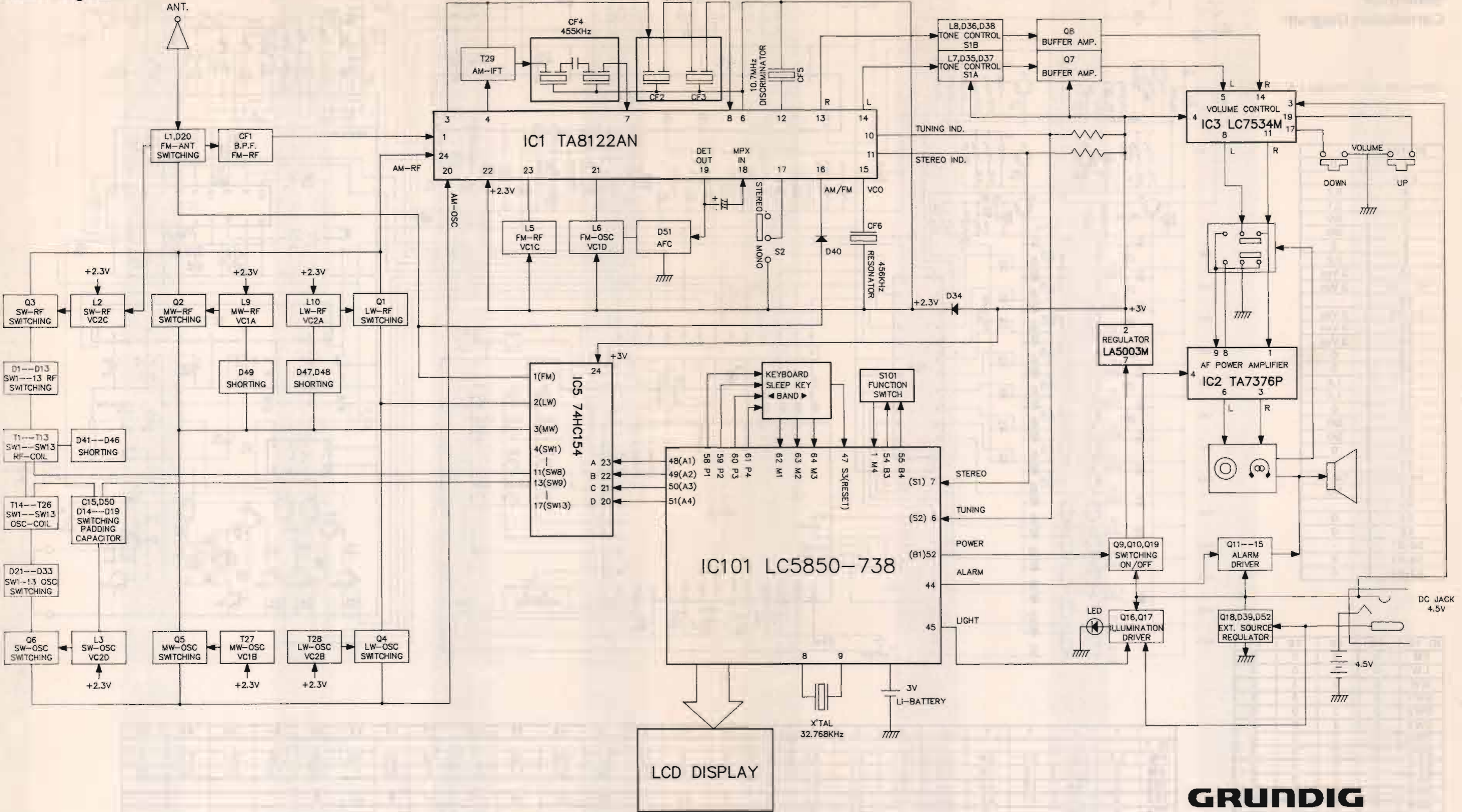

GRUNDIG
Yacht Boy 230
Yacht Boy 230 Italia

Änderungen vorbehalten
Subject to alteration
Sous réserve de modifications ultérieures
Con riserva di modifiche
Reservado el derecho de modificación

Service Manual Yacht Boy 230/Yacht Boy 230 Italia
Service Manual Yacht Boy 230/Yacht Boy 230 Italia
Instructions de Service Yacht Boy 230/Yacht Boy 230 Italia
Manuale di servizio Yacht Boy 230/Yacht Boy 230 Italia
Manual de Servicio Yacht Boy 230/Yacht Boy 230 Italia

Sachnummer 72010-714.95
Part number 72010-714.95
Référence 72010-714.95
No. art. 72010-714.95
Número de código 72010-714.95